

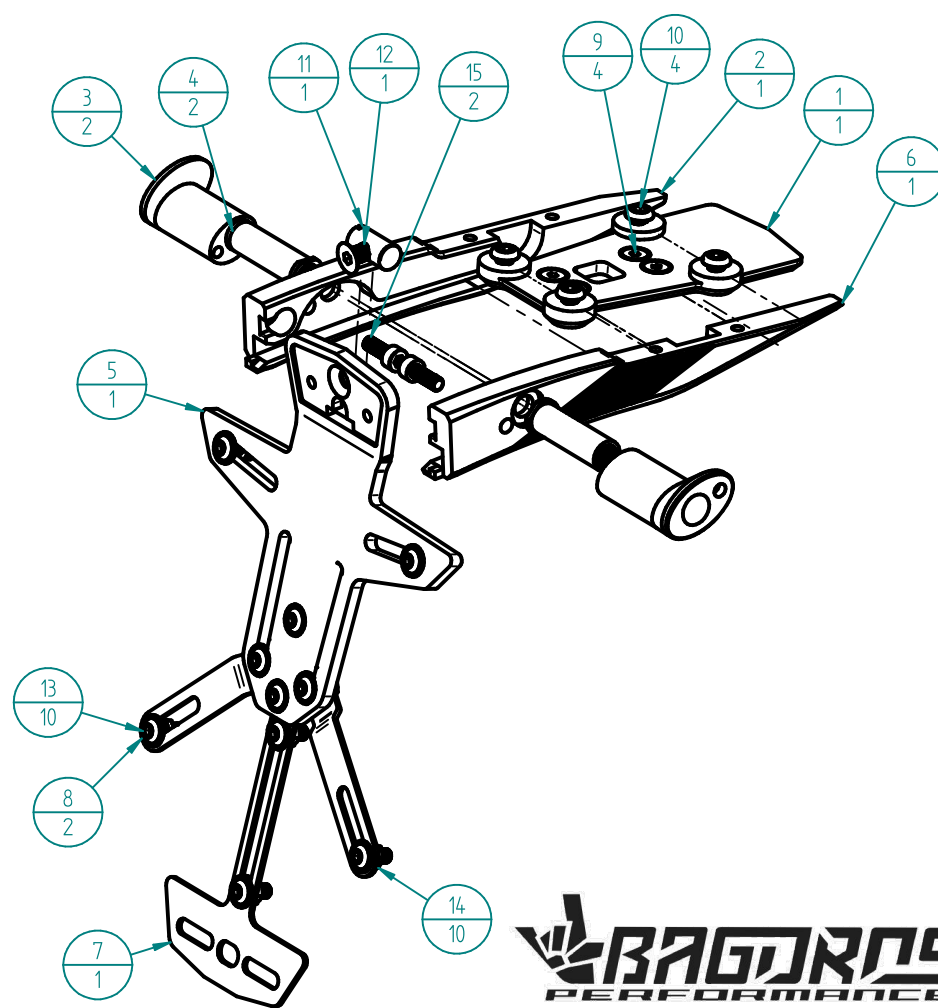

TAIL TIDY
Installation Instructions

KTM 1290 SUPER DUKE R
MODEL YEAR 2020+



Item Number	Title	Quantity
1	Main Plate	1
2	Body Left	1
3	Blinker Holder	2
4	Blinker Nut	2
5	Plate Holder	1
6	Body Right	1
7	Reflector holder	1
8	Licence Plate Extension - Long	2

Item Number	Title	Quantity
9	BOLT M5 x 10 A2 DIN 7991 ISO 10642	4
10	BOLT M6X8 A2 DIN/ ISO7380-1	4
11	Barrel Nut M6 F110x20	1
12	BOLT M6X14 A2 DIN7991 ISO10642	1
13	BOLT M5X12 A2 DIN/ ISO7380-2	10
14	NUT M5 A2 DIN6923 ISO4161	10
15	BOLT M5X14 I8.8VZ DIN912 ISO4762	2

STEP 1

Open the trunk of your bike and demount the original Tail Tidy of your bike by removing the 4 screws holding it on.

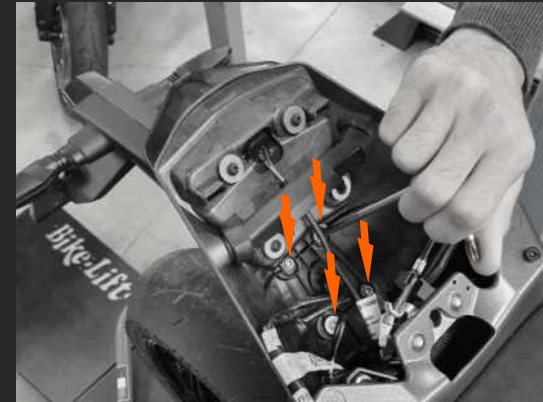

STEP 2

Uncrew the 2 bolts on each side holding together the tail tidy. Separate the two halves and remove the license plate light and the turn signals.

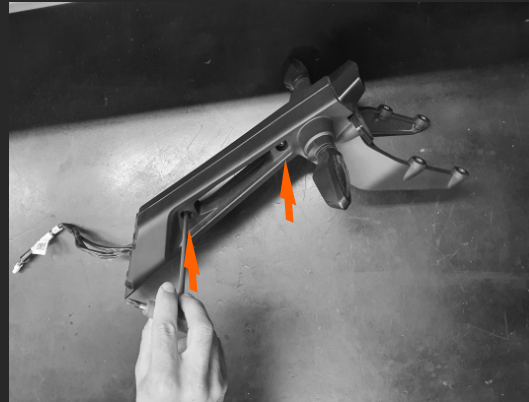
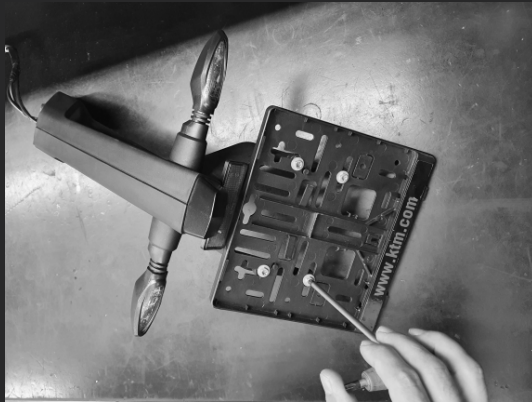

STEP 3

Place the Blinker Nut inside the Blinker Holder. Take the OEM blinker and place it inside the assembly. Now tighten the Blinker Nut with a 13mm wrench. Repeat for other side.

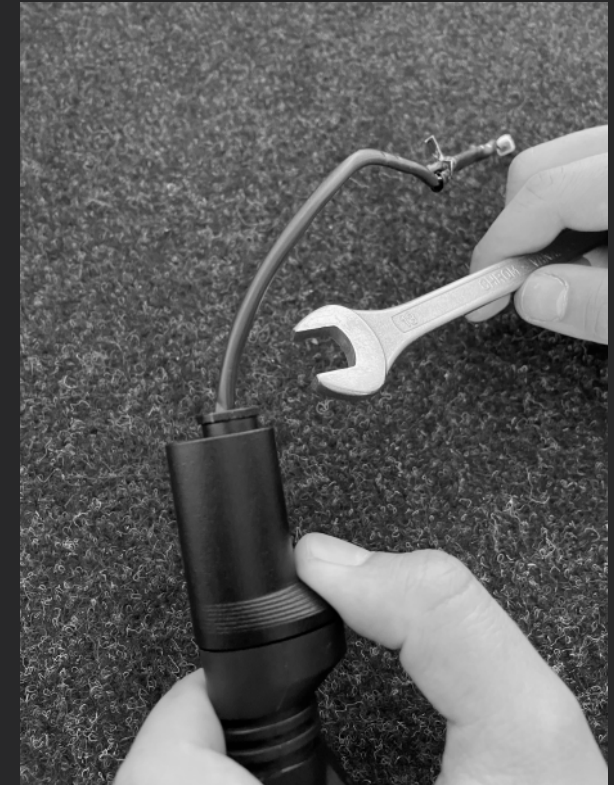

STEP 3.1

Place the Blinker trough the bigger hole and align the smaller hole with the Blinker holder. Now take the Bolt and place it as shown in the picture and tighten it down. Repeat for other side.



STEP 4

Take the Barrel Nut and place it inside the Body like shown in the Picture. You have to place it so that the hole is facing out.



STEP 5

Next step is to take the license plate light and place it trough the bottom Plate Holder hole.



STEP 6

Now you can join the two halves together into one piece. Align the cables into the milled slot as shown in PICTURE 3.



STEP 7

You can now place the plate holder on to the two halves and screw the M6 bolt into the barrel nut. When you're done pull the license plate cable all the way trough.



STEP 8

Place the OEM license plate light screws back in their place and tighten the light down.



STEP 9

You are almost there. Put all cables (2x signal cables and light cable) through the big hole on the main plate. Then place the 4 M6 bolts in the holes and tighten them down.

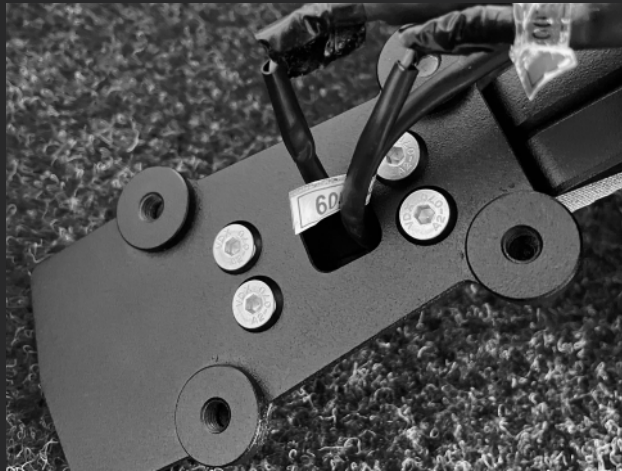

STEP 10

Mount two plate extendors to the lower part of the Tail Tidy as seen in pictures with 4x bolts and 4x nuts.



STEP 11

Now just repeat the step from STEP 1 just in the reverse order and you're all done (place back the 4 OEM screws and tighten them down, then reconnect the wires and close the seat cover).

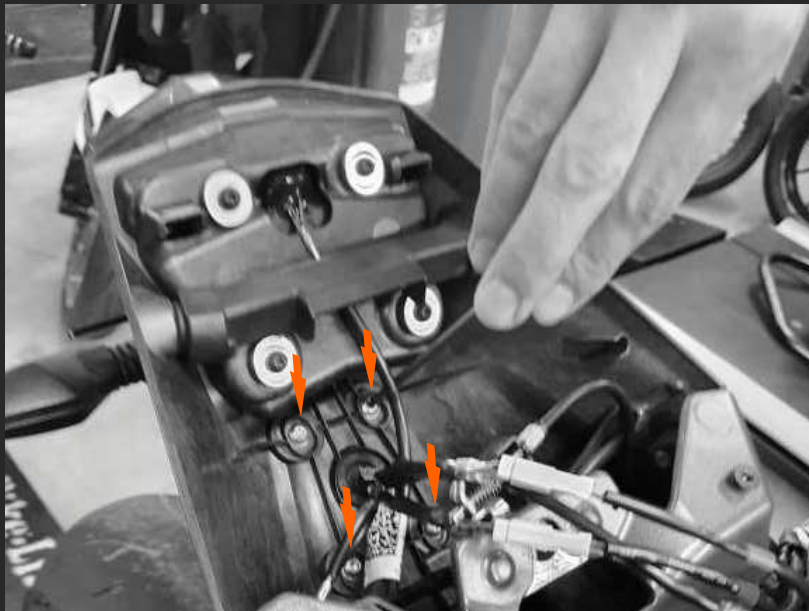

IMPORTANT

It is recommended that periodic inspections are made to ensure that all bolts are tightened to the specified torque settings. Should the bike be involved in an accident a thorough inspection should be made and any components that have taken an impact, no matter how small, be replaced.

The manufacturer or supplier cannot be held responsible for products that are incorrectly mounted or inappropriately used.

It is recommended to check all connections regularly for tightness of fit.



<https://bagorosperformance.com/product/tail-tidy-ktm-1290-super-duke-r/>